

feather&black

Jacob Tall Chest Assembly Guide



Welcome to the Feather & Black community.

Since 2004, we've been passionately helping our customers create beautiful bedrooms with an exceptional level of quality and expertise. We know your home is a truly special place, so it's a responsibility we don't take lightly. That's why all of our furniture is handcrafted using only the finest materials. Considering every fine detail, every twist, turn and corner, we create pieces that truly reflect your style.

We hope you love this stunning new addition to your home. If we can be of any assistance, please don't hesitate to get in touch with us. You can call 01243 380600 (option 2), email customerservices@featherandblack.com or chat with a member of our team live at featherandblack.com.

We simply adore seeing our furniture come to life in its forever home, so don't forget to share your style with the world. We'd love for you to tag us on Instagram @featherandblack and include #featherandblack so we can bask in its beauty too!

From our home to yours, thank you for choosing thoughtfully crafted furniture that's made to be cherished.

Sincerley,

The Feather & Black Team

feather&black

Jacob Tall Chest - Assembly Instructions

Product size: 1145mm H x 624mm W x 458mm D

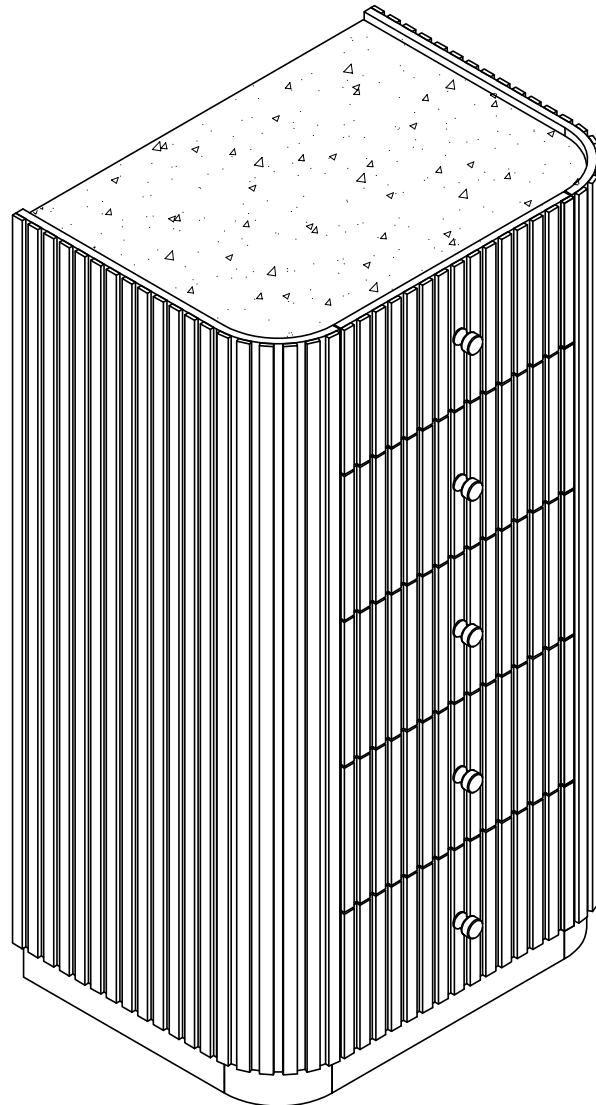

If you require any advice during assembly, please call our customer service team on 01243 380600

Please retain these assembly instructions for future use

Jacob Tall Chest

Before you start

Thank you for purchasing this Jacob Tall Chest.

Please read these instructions fully prior to assembly to familiarise yourself with the various stages of construction. Carefully open all packs supplied and check the contents against the parts and fittings check list.

Do not destroy any of the packaging until you are certain that you have all the necessary parts for the assembly.

This item is heavy once assembled. Please try to assemble the item as close as possible to the point of use. Take care when moving the item to avoid personal injury or damage to the product and always lift rather than drag.

There are small components used in the construction of this furniture as well as plastic packaging, these should be kept away from young children whilst assembling.

Product Safety

All assembly fastenings should always be tightened properly, and care should be taken to ensure that no fittings are loose.

Periodically check and ensure that all components are in their proper position, free from damage, and that all connectors are tight.

Please note depending on the lighting, positioning and surroundings of your room, the shade of the colour can sometimes appear slightly different. Over a period of time the colour might lighten or fade slightly due to light exposure.

Product Care

To clean, slightly moisten cloth with water and wipe surfaces. A damp cloth holds dust and prevents damage. repeat with a dry, soft, lint-free cloth. Do not use abrasives or cleaning products which may contain ammonia or solvents.

Number of people required to assemble

Two people to assemble the product and two people to lift in to position.



Time to assemble



30 minutes

Necessary tools



Flathead
Screwdriver

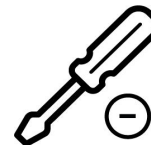

Crosshead
Screwdriver



Tape measure

Missing parts or faulty products

If you are missing any fixtures or fittings during assembly, or a part is unfortunately faulty please call our customer service team on 01243 380600

Jacob Tall Chest

Components supplied (not actual size)

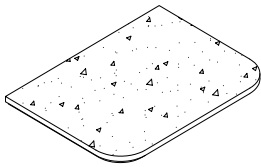

A: Marble Top
Quantity: 1 pc
Box: 2

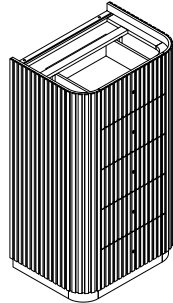

B: Chest part
Quantity: 1 pc
Box: 1

Fixtures and fittings supplied (not actual size)

Box: 1

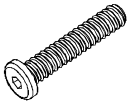

C: Bolt
M6x25 (mm)
Quantity: 4 pcs



D: Allen Key
M4x110 (mm)
Quantity: 1 pc

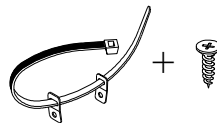

E: Wall Fixing
Quantity: 1 set



feather&black

Jacob 3 Drawers

1.

Put the marble top (A) rest on the chest (B) , then gently fit it to the chest.

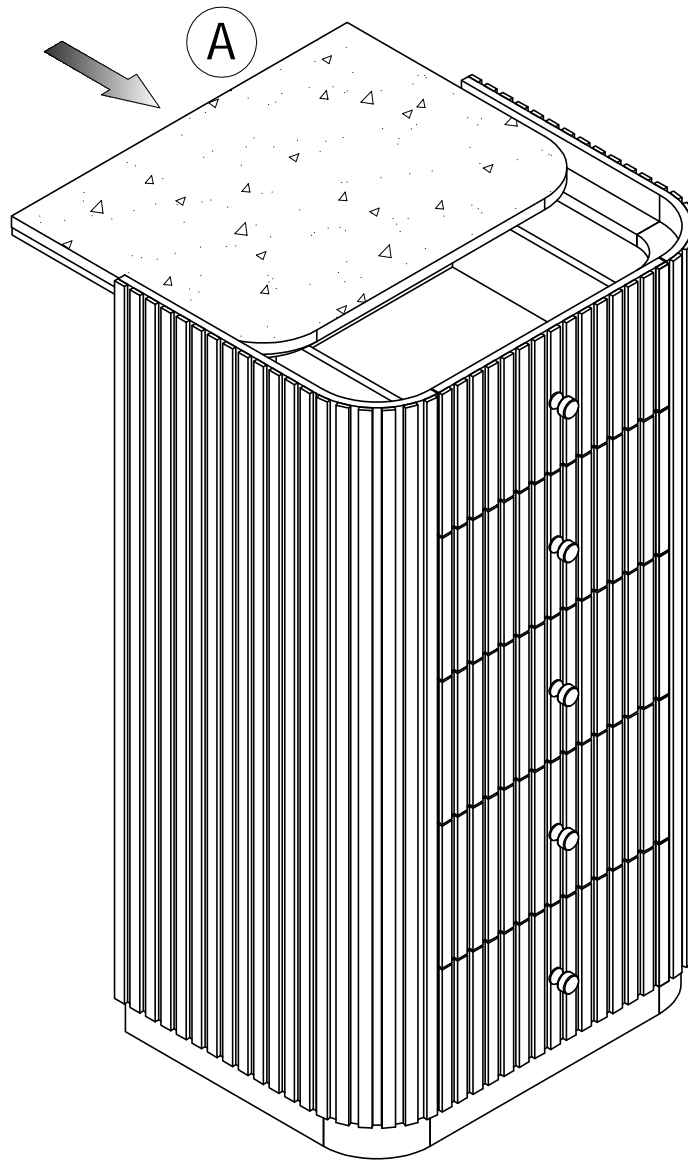

feather&black

Jacob Tall Chest

2.

Use bolts (C) and allen key (D) to attach the marble top (A) to the chest (B).

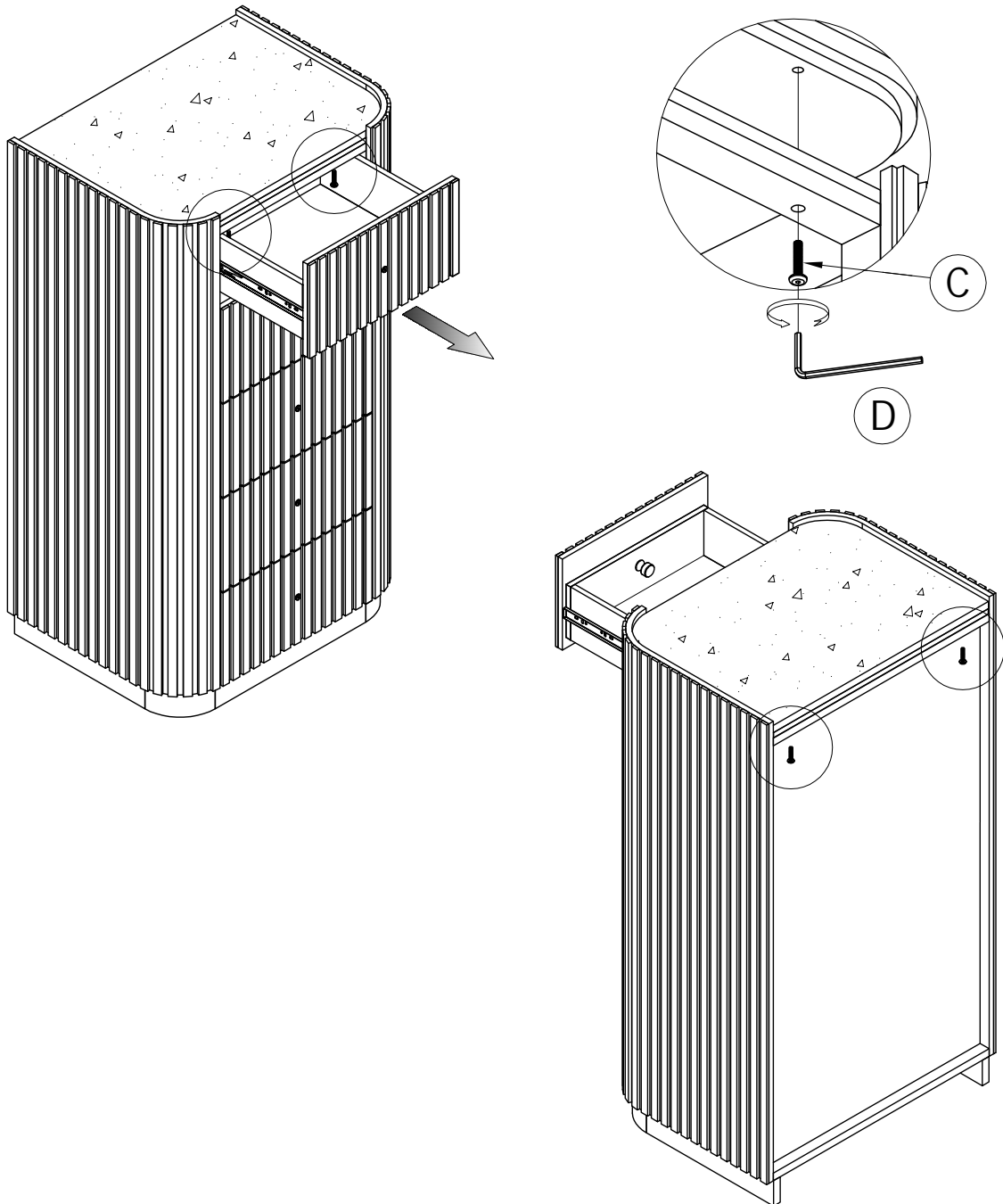

C: Bolt M6x25mm

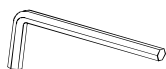

D: Allen Key

Jacob Tall Chest

3.

Remove the drawer's handles using allen key (D), bring the handles to the front of the drawers and reattach them.

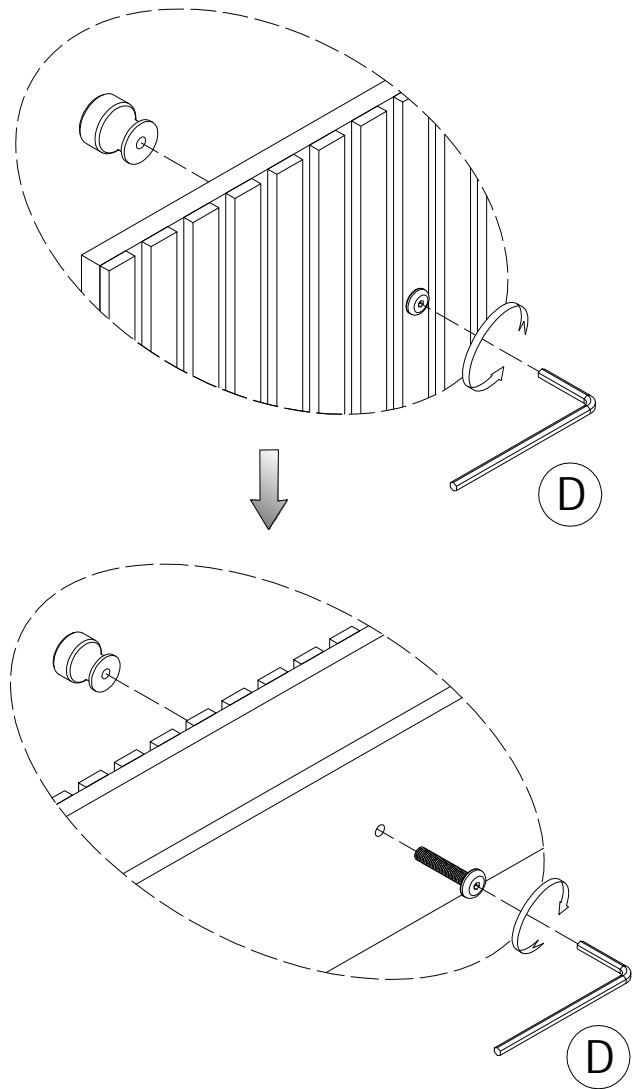
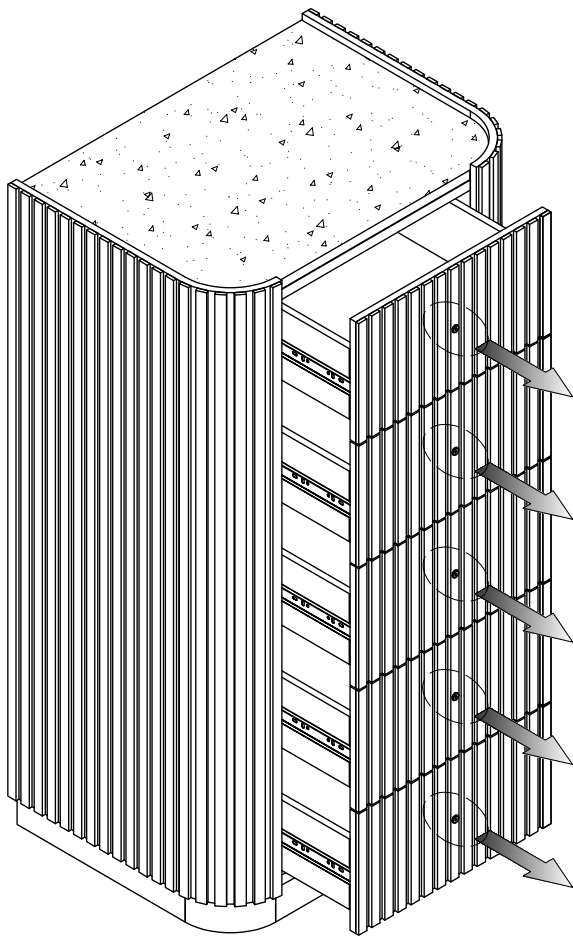

D: Allen Key

Jacob Tall Chest

4.

***WARNING:** it is strongly recommended that you anchor this product to a wall.

- Attach the anti-tilt straps (E) to the back using provided screws and bracket. Then secure the straps to the wall through the brackets (wall screws not included).

- As wall materials vary, screws for fixing to the wall are not included. For advice on suitable screw systems, please refer to the guide for wall mounting and fixing on the following page.

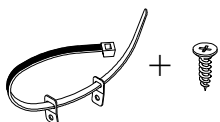
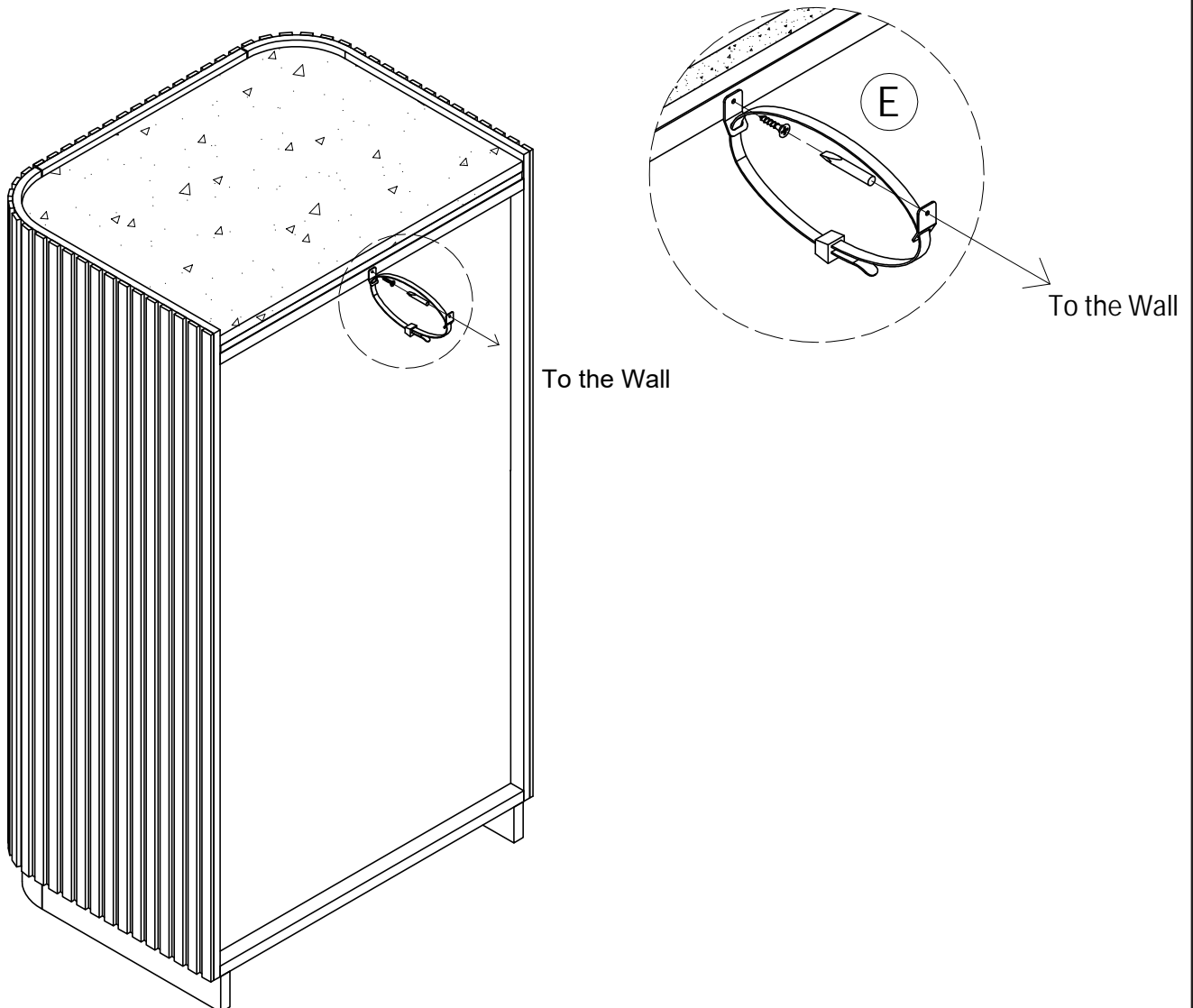

E: Wall Fixing

Wall Mounting & Fixings

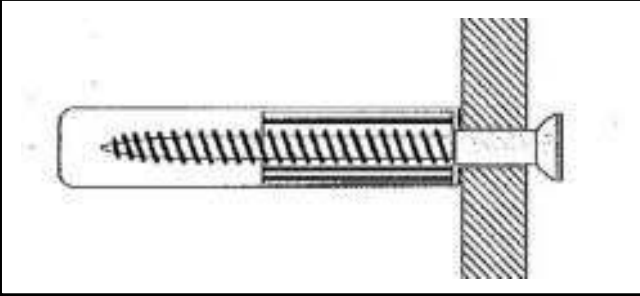

Important:

When drilling into walls always check that there are no hidden wires or pipes ect. Make sure that the screws and wall plugs being used are suitable for supporting your unit. Consult a qualified tradesperson if you are unsure.

HINTS:

- 1) General Rule  Always use a larger screw and a wall plug if you are not sure.
- 2) Ensure you use the recommended drill bit to match the wall plug and hole size.
- 3) Ensure you drill the hole horizontally, do not force the drill or enlarge the hole.
- 4) Take extra care when drilling high walls, ceilings and ceramic tiles. Ensure the plug is fitting below the ceramic tile to avoid splitting or cracking.
- 5) Ensure wall plugs are well fitted and are a tight fit in the drilled hole.

Types of walls

You can use one of the following types of wall plug if your walls are made of brick, breeze block, concrete, stone, wood or plaster board.

No. 1 "Standard" Wall Plug General Wall Materials.

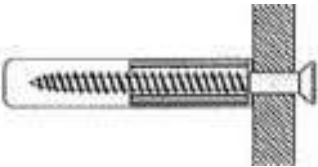

These come in various sizes and are made from plastic or sometimes wood fiber.

No. 2 "General Purpose" Wall Plug Aerated/Breeze Block.

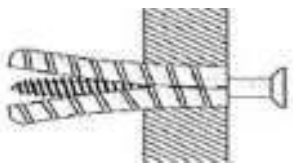

General aerated blocks should not be used to support heavy loads, use a specialist fitting in this case. For light loads, a General Purpose Plug can be used.

No. 3 "Shield Anchor" Wall Plug Heavy loads.

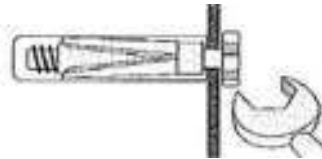

For use with heavier loads such as TV & HiFi Speakers and Satellite Dishes etc.

No. 4 "Cavity Fixing" Wall Plug.

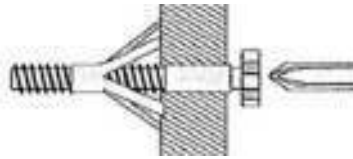

For use with plaster board partitions or hollow wooden doors.

No. 5 "Cavity Fixing Heavy Duty" Wall Plug.

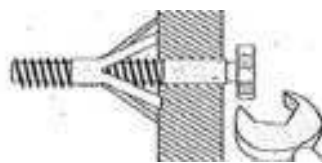

For use when fitting or supporting heavy loads such as shelving, wall cabinets, coat racks.

No. 6 "Hammer Fixing" Wall plug.

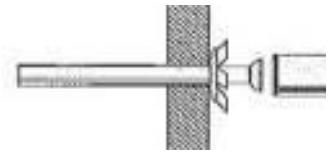

For use with walls stuck with plaster board. The hammer fixing allows it to be fixed to the wall rather than the plaster board. Always check the fixing is secure to the retaining wall.

Care & Maintenance



SAFETY

Always check the fitting and location to ensure your safety in and around the home.

Care & Maintenance



FITTING

From time to time check the fitting to ensure the wall plugs or screws do not become loose.

feather&black

featherandblack.com