

feather&black

Rae bed
Assembly Guide

Welcome to the Feather & Black community.

Since 2004, we've been passionately helping our customers create beautiful bedrooms with an exceptional level of quality and expertise. We know your home is a truly special place, so it's a responsibility we don't take lightly. That's why all of our furniture is handcrafted using only the finest materials. Considering every fine detail, every twist, turn and corner, we create pieces that truly reflect your style.

We hope you love this stunning new addition to your home. If we can be of any assistance, please don't hesitate to get in touch with us. You can call 01243 380600 (option 2), email customerservices@featherandblack.com or chat with a member of our team live at featherandblack.com.

We simply adore seeing our furniture come to life in its forever home, so don't forget to share your style with the world. We'd love for you to tag us on Instagram @featherandblack and include #featherandblack so we can bask in its beauty too!

From our home to yours, thank you for choosing thoughtfully crafted furniture that's made to be cherished.

Sincerley,
The Feather & Black Team

feather&black

Rae bed - Assembly Instructions

Product size: Double: 1250mm H x 1996mm W x 1450mm D
King: 1250mm H x 2096mm W x 1600mm D
Super King: 1250mm H x 2096mm W x 1910mm D

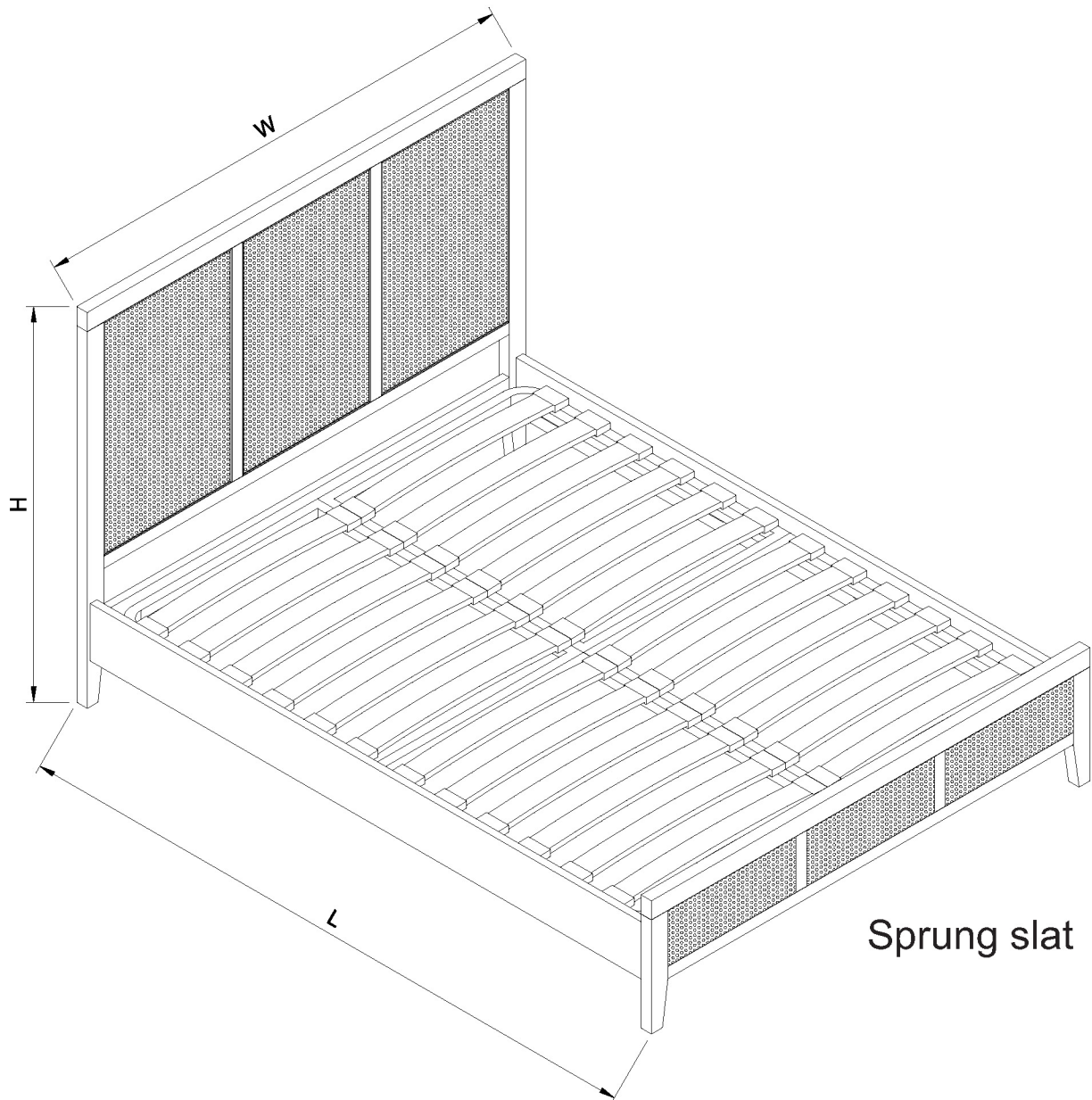

If you require any advice during assembly, please call our customer service team on 01243 380600

Please retain these assembly instructions for future use

feather&black

Rae bed

Before you start

Thank you for purchasing this Jacob Bed.

Please read these instructions fully prior to assembly to familiarise yourself with the various stages of construction. Carefully open all packs supplied and check the contents against the parts and fittings check list.

Do not destroy any of the packaging until you are certain that you have all the necessary parts for the assembly.

This item is heavy once assembled. Please try to assemble the item as close as possible to the point of use. Take care when moving the item to avoid personal injury or damage to the product and always lift rather than drag.

There are small components used in the construction of this furniture as well as plastic packaging, these should be kept away from young children whilst assembling.

Product Safety

All assembly fastenings should always be tightened properly, and care should be taken to ensure that no fittings are loose. Periodically check and ensure that all components are in their proper position, free from damage, and that all connectors are tight.

Please note depending on the lighting, positioning and surroundings of your room, the shade of the colour can sometimes appear slightly different. Over a period of time the colour might lighten or fade slightly due to light exposure.

Product Care

To clean, slightly moisten cloth with water and wipe surfaces. A damp cloth holds dust and prevents damage. repeat with a dry, soft, lint-free cloth. Do not use abrasives or cleaning products which may contain ammonia or solvents.

Number of people required to assemble

Two people to assemble the product and two people to lift in to position.



Time to assemble



60 minutes

Necessary tools

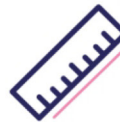

Tape measure

Missing parts or faulty products

If you are missing any fixtures or fittings during assembly, or a part is unfortunately faulty please call our customer service team on 01243 380600

feather&black

Rae bed

Components supplied (not actual size)

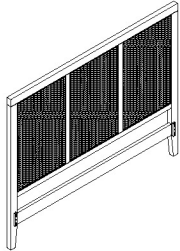

A: Headboard
Quantity: 1 pc

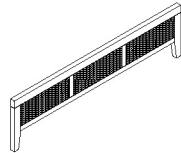

B: Footboard
Quantity: 1 pc

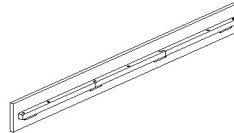

C: Left side rail
Quantity: 1 pc

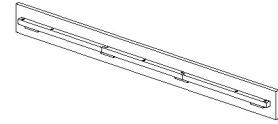

D: Right side rail
Quantity: 1 pc

Fixtures and fittings supplied (not actual size)

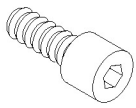

E: Bolt
M6x15 (mm)
Quantity: 8 pcs

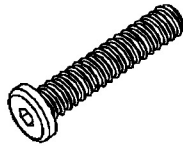

F: Bolt
M6x45 (mm)
Quantity: 4 pcs



G: Flat Washer
M6 (mm)
Quantity: 4 pcs

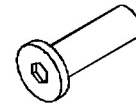

H: Sleeve Nut
M6x20 (mm)
Quantity: 4 pcs

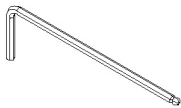

I: Allen Key
M5 (mm)
Quantity: 1 pc

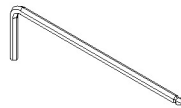

J: Allen Key
M4 (mm)
Quantity: 2 pcs

Note: The following fitting will be found in the box which contains the Sprung Frame, NOT with the bedframes Assembly Kit

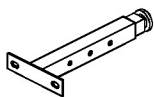

K: Outer support leg
Quantity: 2 pcs

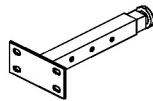

L: Centre support leg
Quantity: 1 pc



M: Bolt
M6x20 (mm)
Quantity: 8 pcs



N: Flat Washer
M6 (mm)
Quantity: 8 pcs

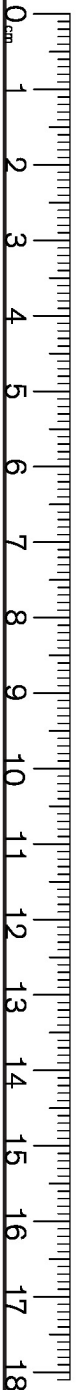

feather&black

Rae bed

Use Bolts (E) to fix the Side Rails (C) and (D) onto Headboard (A) and Footboard (B) by using Allen Key (I).

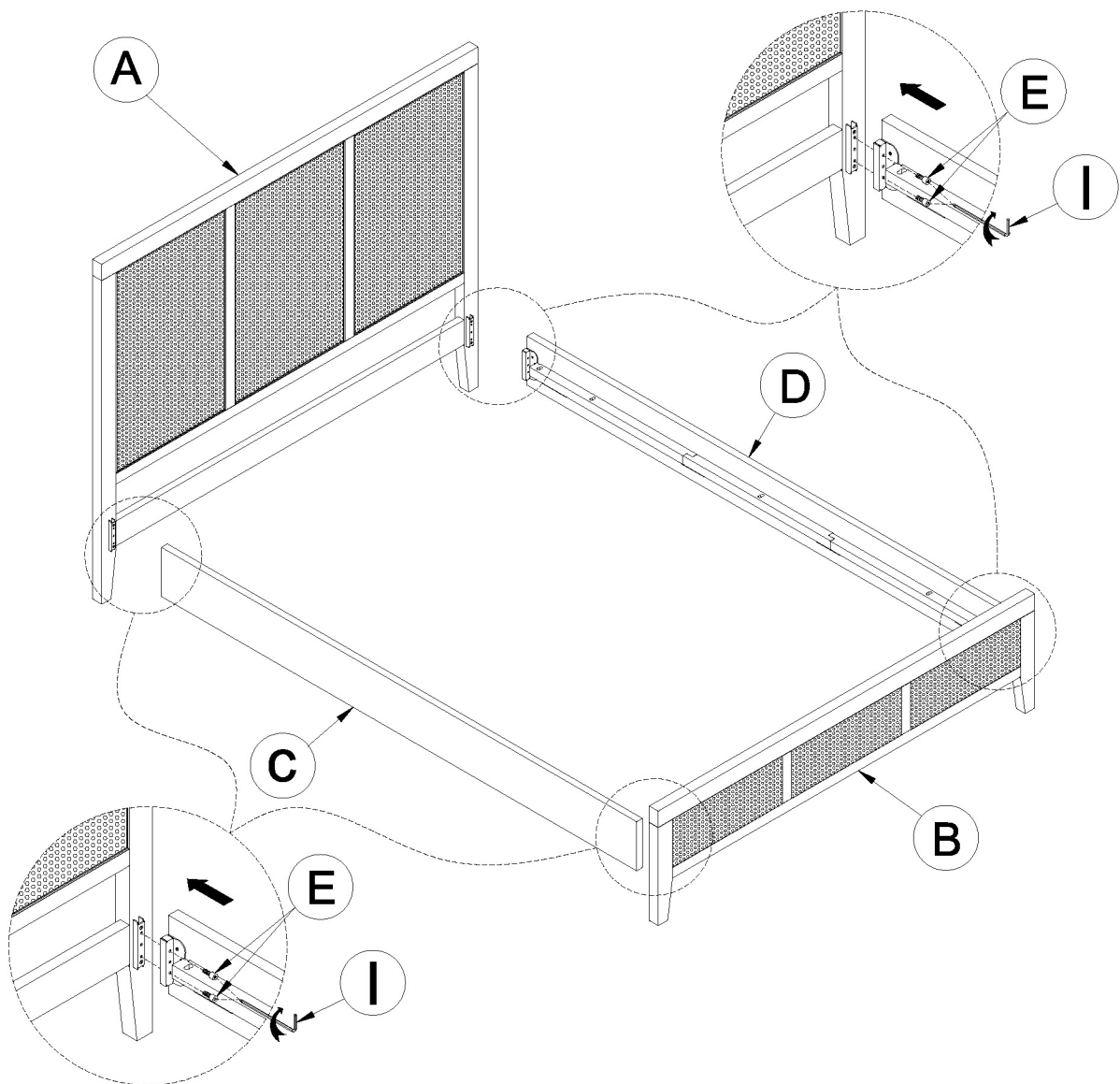

feather&black

Rae bed

Sprung slat system

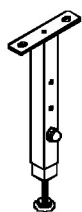
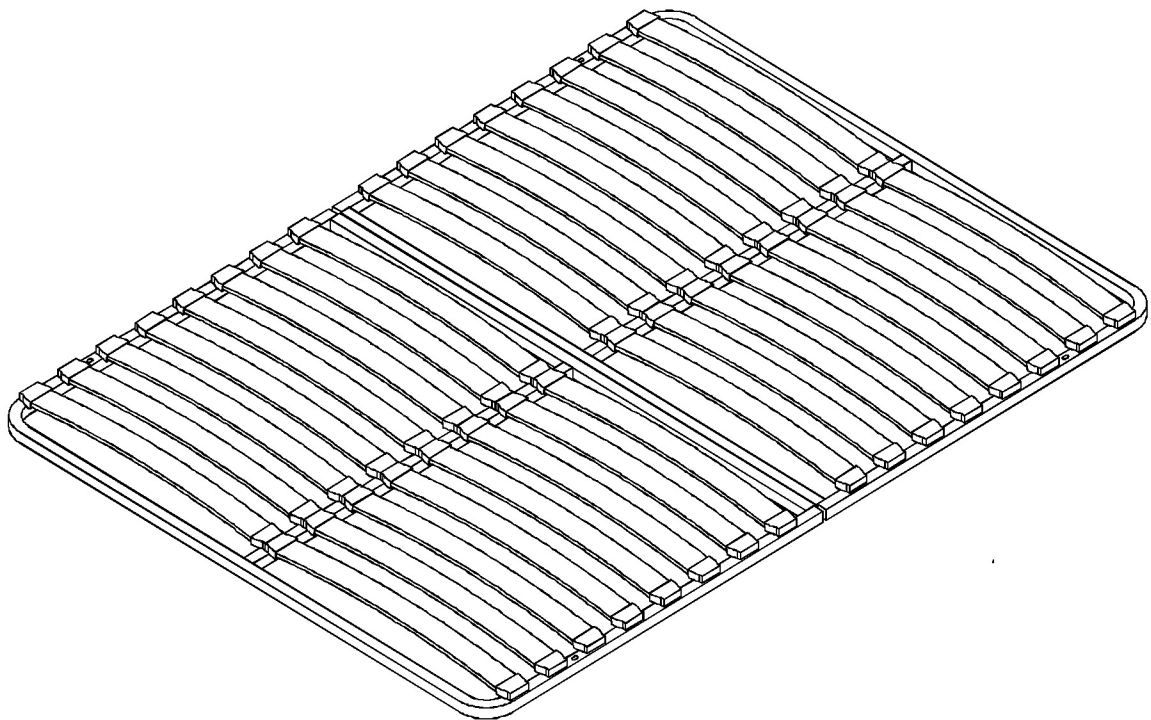

K: Outer support leg

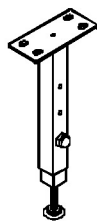

L: Centre support leg

feather&black

Rae bed

Open the sprung slat frame and lay face down on the working surface.
Secure support legs (K&L) to frame using Bolts (M), Washer (N) and Allen Key (J).

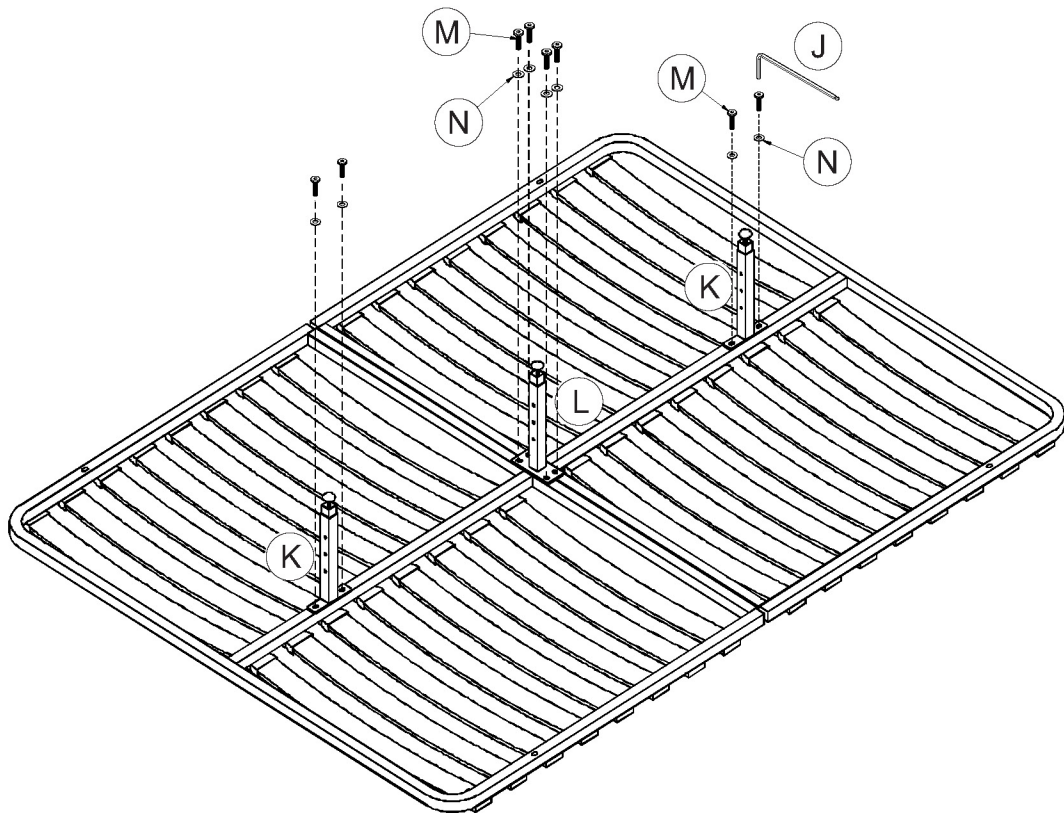

Adjust leg height to suit bed frame

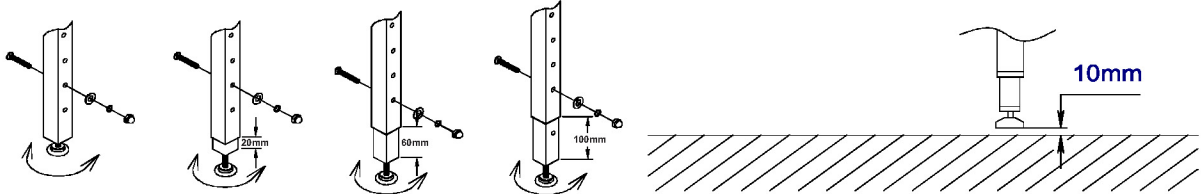

feather&black

Rae bed

- Turn the metal slat frame upward and carefully lower it into the bed. Ensure the frame rests on the side rail, align the holes in the slat frame with those in the side rail.
- Secure the slat frame to the side rail by threading Bolts (F) & Flat Washer (G) through the corresponding holes into the Sleeve Nuts (H). Finally, tighten the Bolts (F) using Allen Key (J).

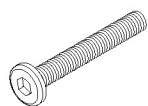
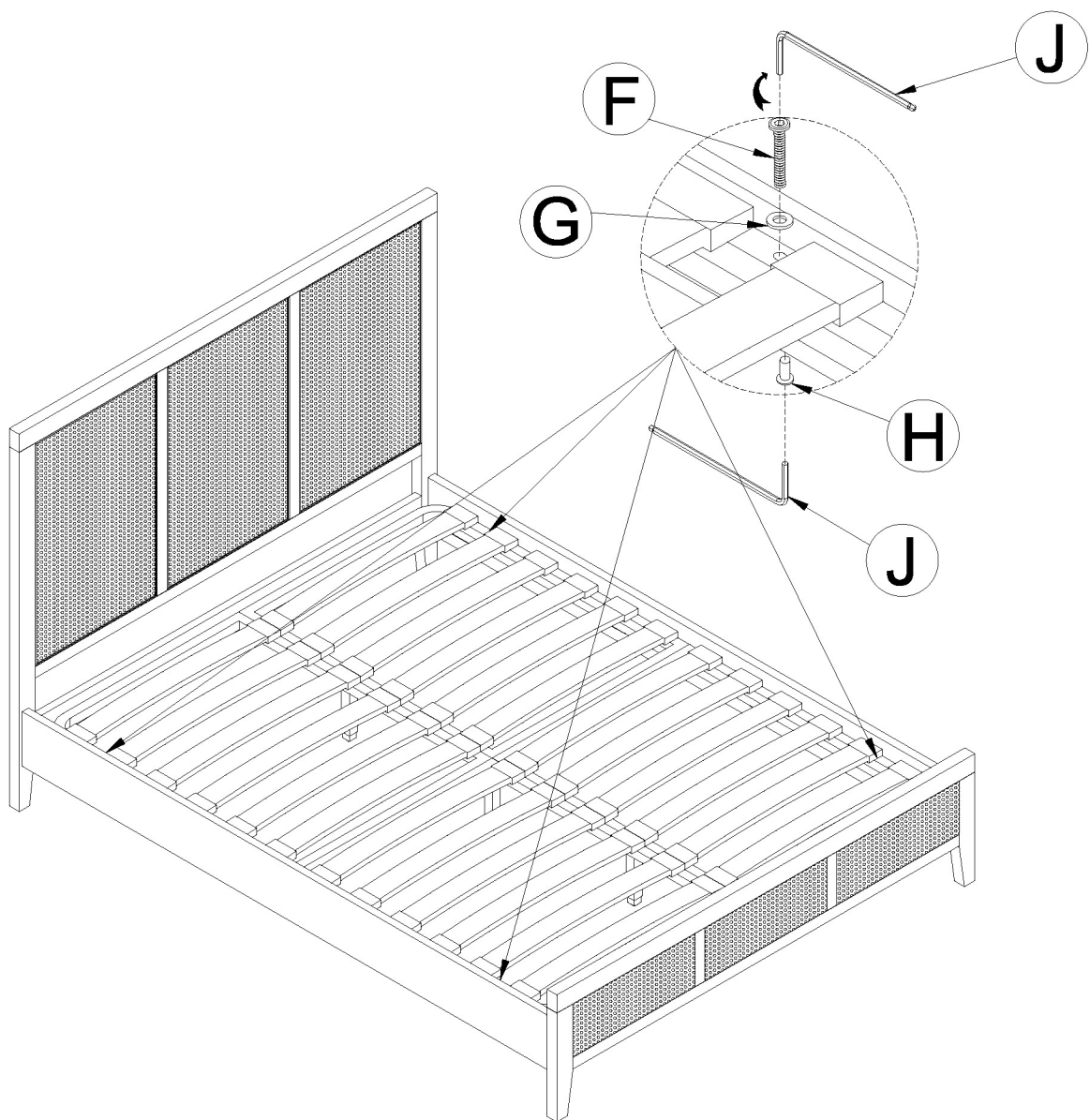

F: Bolt
M6x45mm



G: Flat Washer
M6



H: Sleeve Nut
M6x20mm



J: Allen Key
M4

feather&black

featherandblack.com